

# STATO MODIFICATO

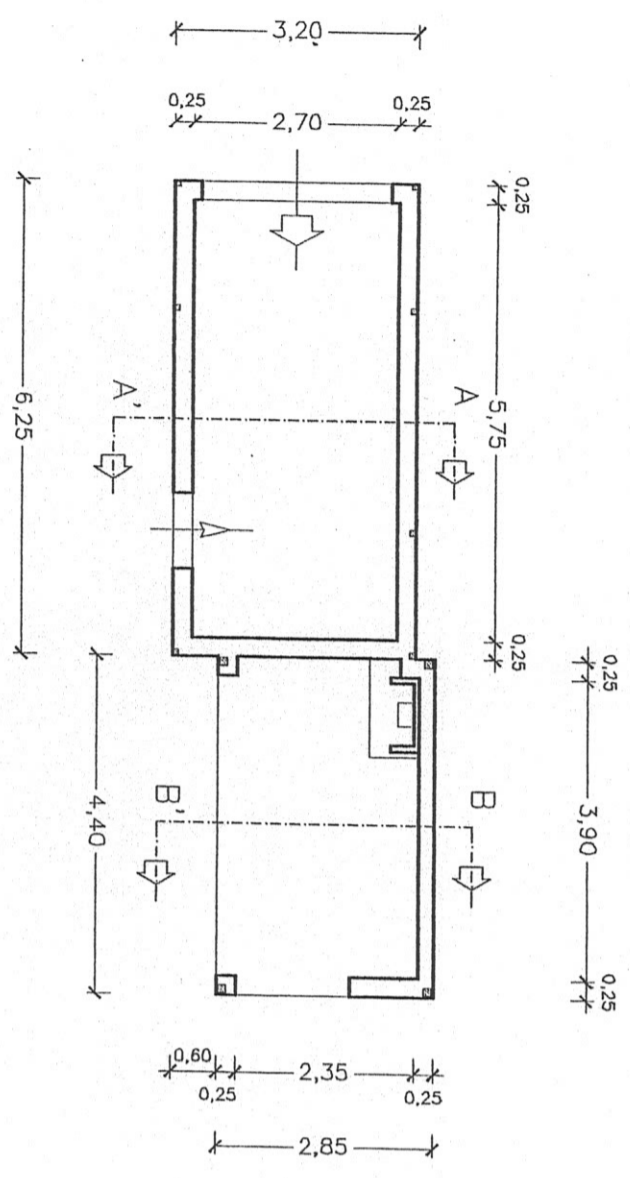

Pianta Piano Terreno

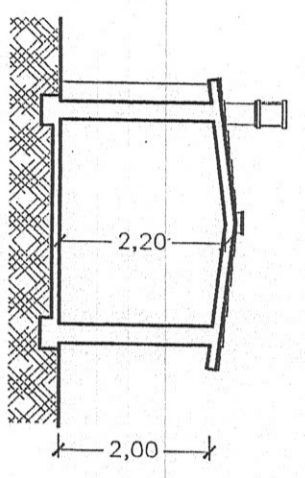

Sezione A-A'

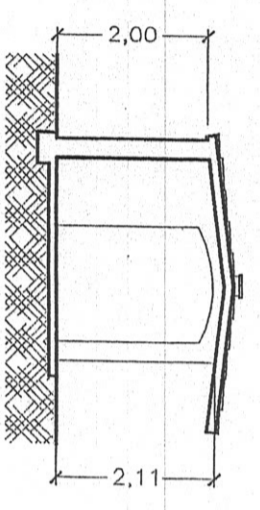

Sezione B-B'

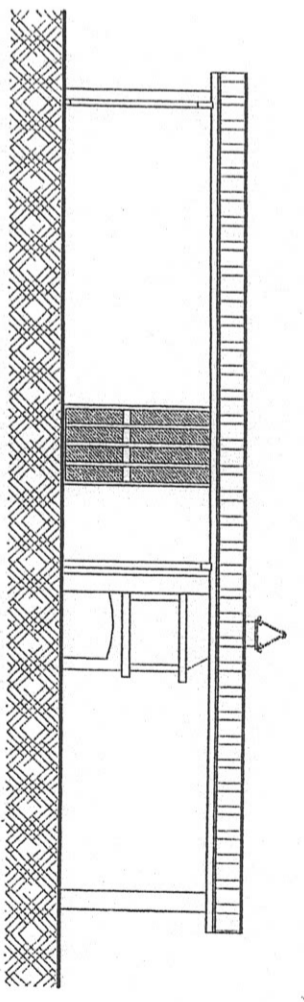

Prospetto Ovest

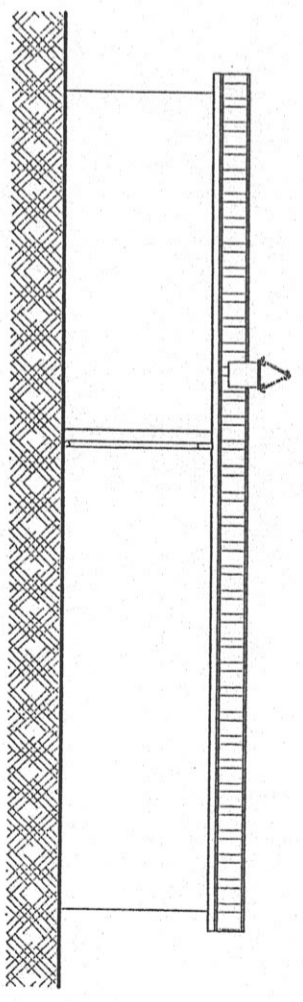

Prospetto Est

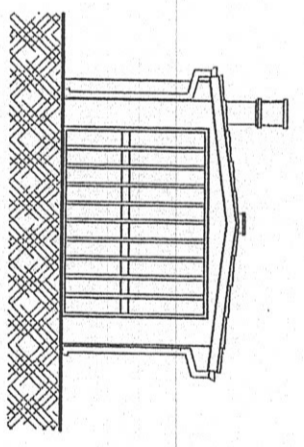

Prospetto Nord

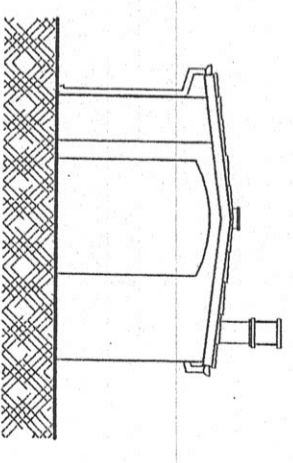

Prospetto Sud

# STATO ATTUALE

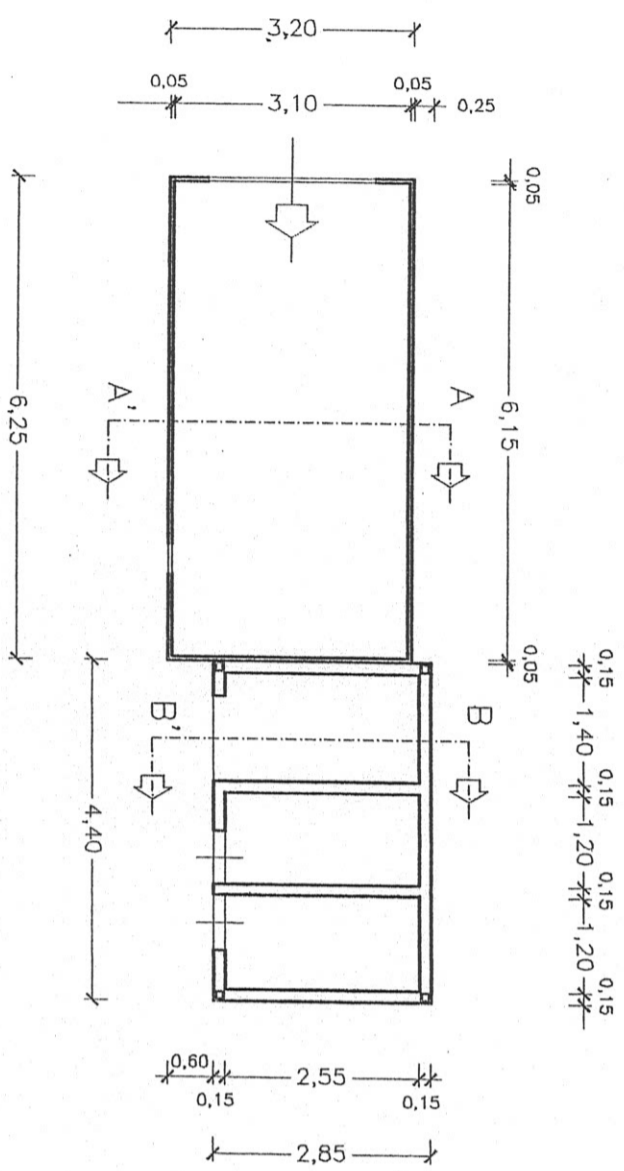

Pianta Piano Terreno

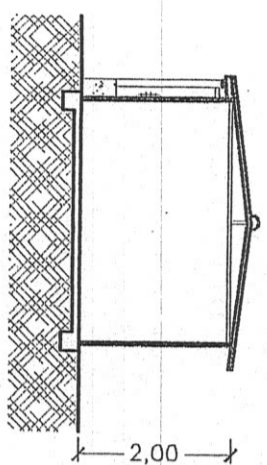

Sezione A-A'

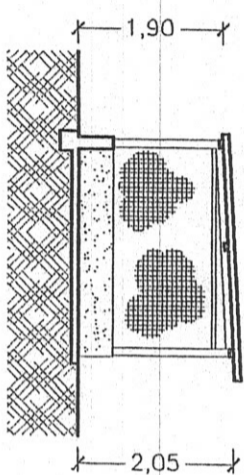

Sezione B-B'

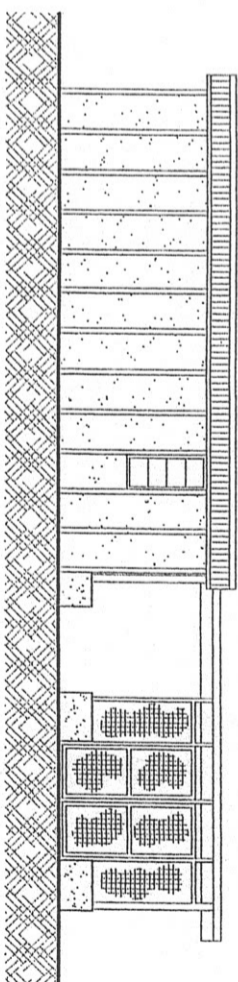

Prospetto Ovest

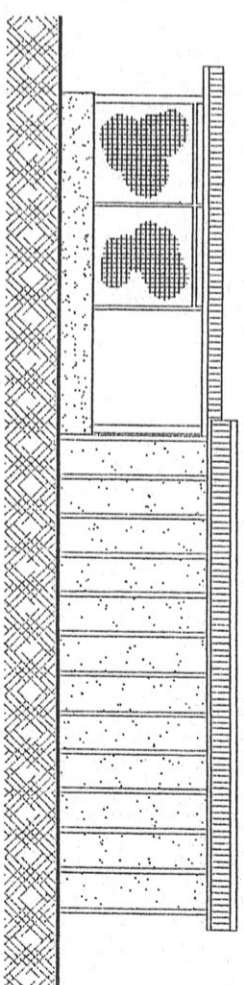

Prospetto Est

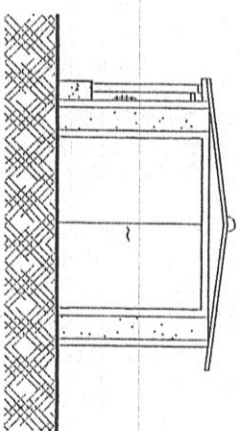

Prospetto Nord

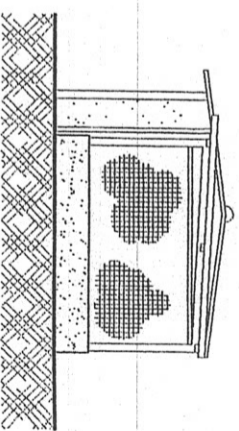

Prospetto Sud